



TWINSON COMPOSITE FENCING

Installation guide

The natural warmth of wood, the durability and low maintenance of PVC

Fencing quick guide

1.15 / 2.35m

Dimensions

Height of screen: 1.15 or 1.85m
 Length/step of the screen: 2019mm
 Length of the planks: 2000mm

On wall

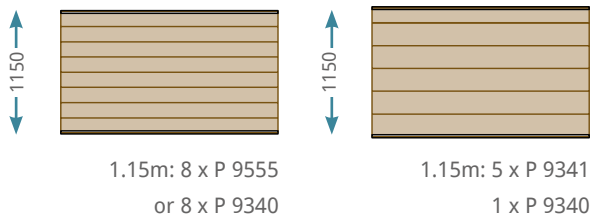

In concrete

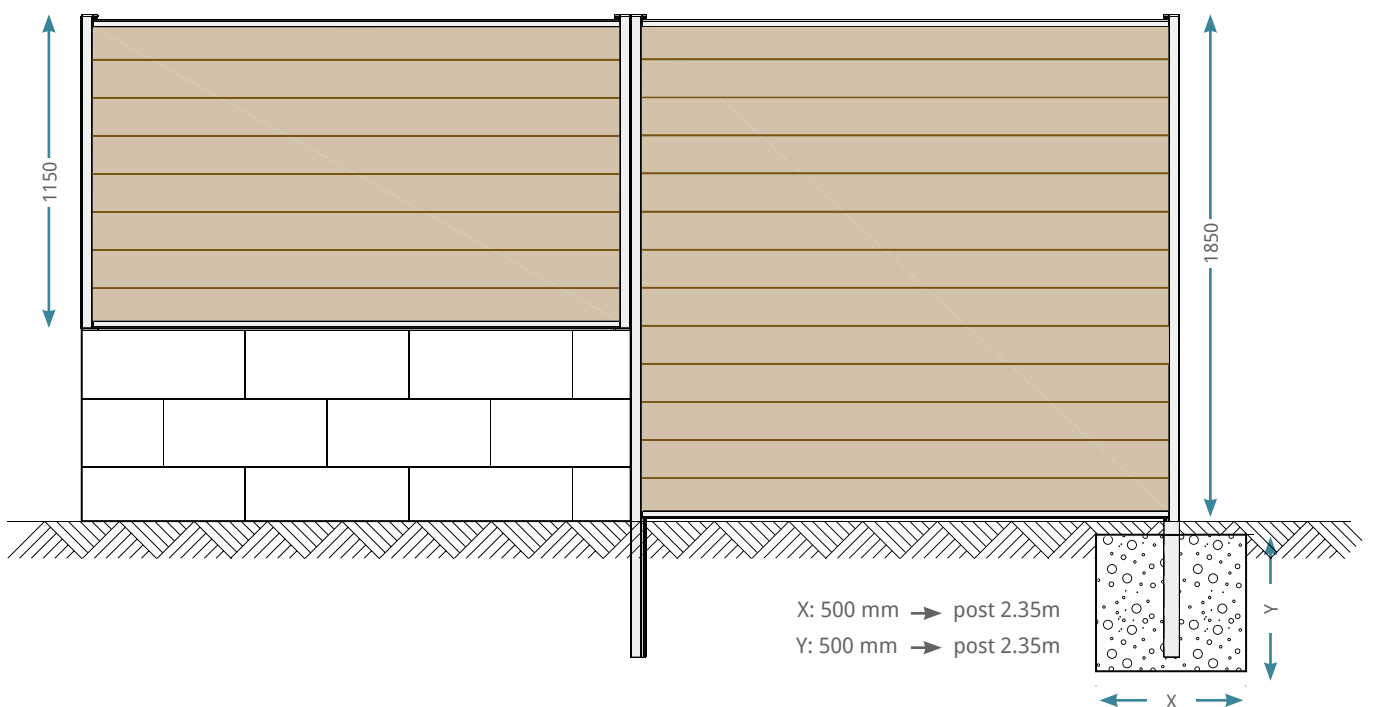
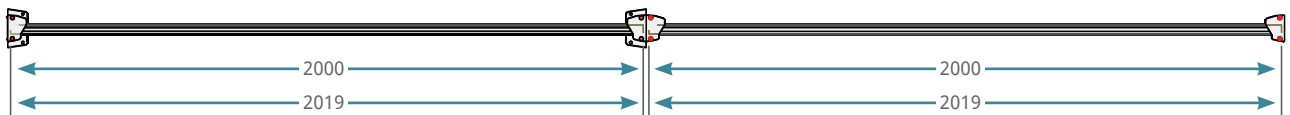
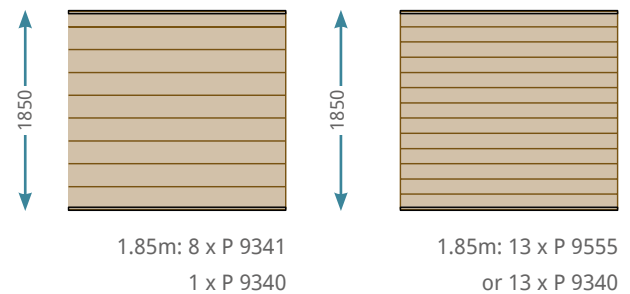

General information

Start post

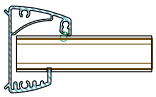

Connection post

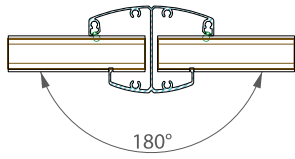

Corner post 90° - 179°

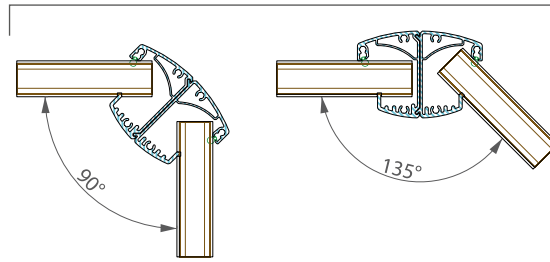

End post

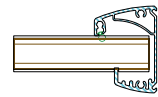

! Cut the planks at exactly 2000m

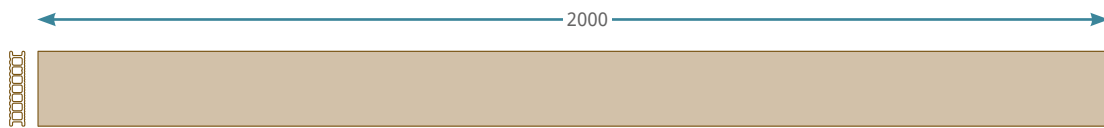

Tools: depending on installation method and application

- Shovel and spade
- Post hole digger or soil drill
- Spirit level
- String line
- Screwdriver
- Drilling machine and HSS/concrete drills
- Jigsaw
- Laser
- Concrete mixer



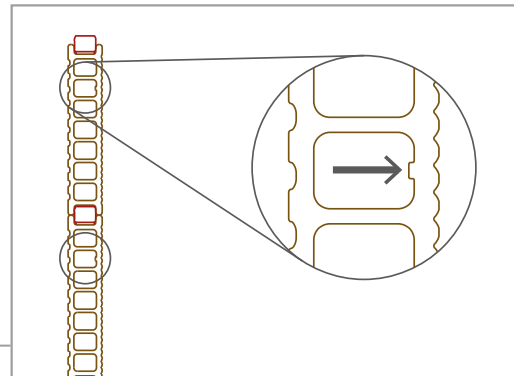



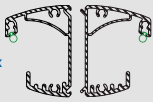

- **No installation $\leq 0\text{ }^{\circ}\text{C}$**
- **Installation forbidden on terrace**
- **Install the planks in the same direction**



Overview kits

Kit P 9282





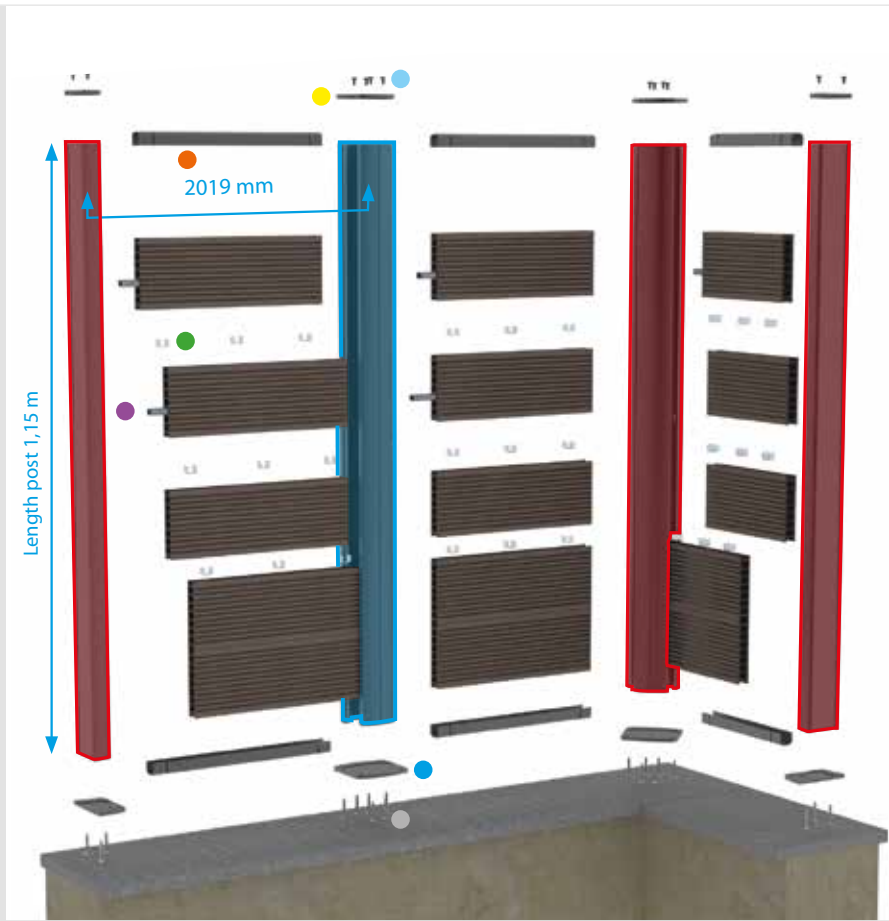

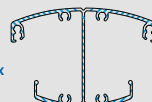

1x  **Start - End / Cornerpost**

- 1x 
- 21x 
- 2x 
- 1x 
- 2x 
- 1x 
- 4x 
- 6x 









Kit P 9274

1x  **Connection post**

- 1x 
- 21x 
- 2x 
- 1x 
- 2x 
- 1x 
- 4x 
- 6x 

Kit P 9283





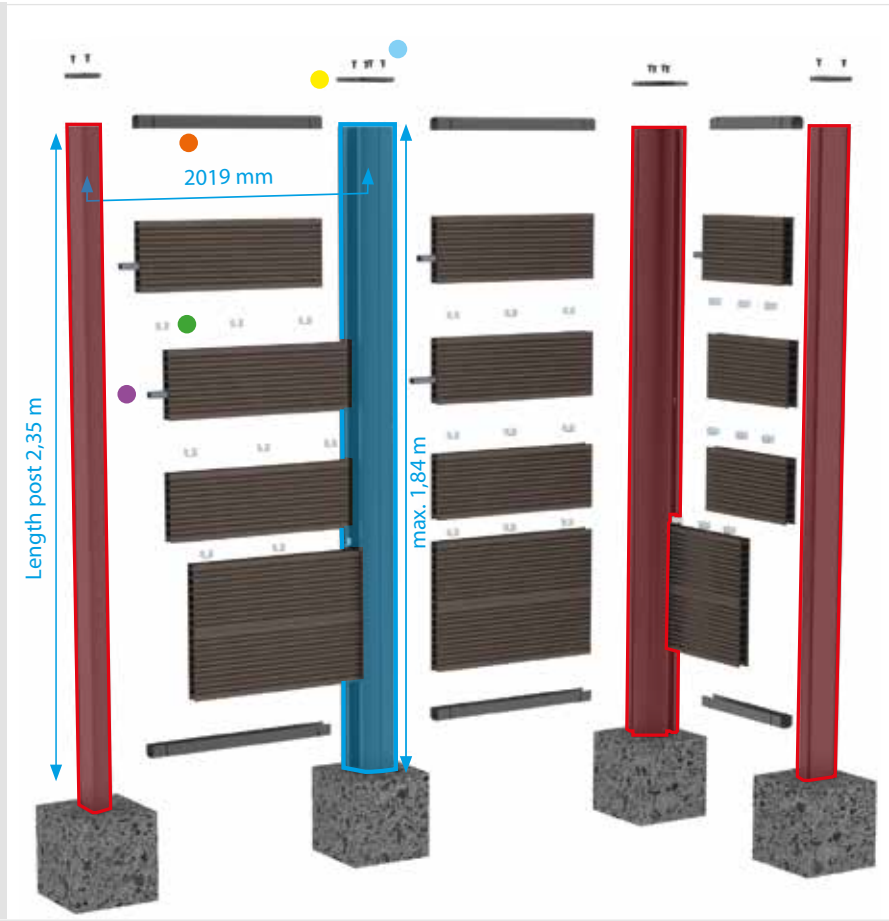

1x  **Start - End / Cornerpost**

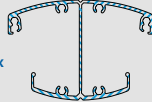
- 1x 
- 36x 
- 2x 
- 1x 
- 3x 
- 4x 





Kit P 9275



1x  **Connection post**

- 1x 
- 36x 
- 2x 
- 1x 
- 3x 
- 4x 

Installation on wall

Type of fencing	Ref	Kit with	Total length of fencing					
			2.0m	4.0m	6.0m	8.0m	10.0m	12.0m
	P 9282 (1.15m)	start/end post	1	1	1	1	1	1
	P 9274 (1.15m)	connection post	0	1	2	3	4	5
	P 9555	planks (linear meter)	16	32	48	64	80	96
	P 9282 (1.15m)	start/end post	-	2	2	2	2	2
	P 9274 (1.15m)	connection post	-	0	1	2	3	4
	P 9555	planks (linear meter)	-	32	48	64	80	96
	P 9282 (1.15m)	start/end post	-	-	3	3	3	3
	P 9274 (1.15m)	connection post	-	-	0	1	2	3
	P 9555	planks (linear meter)	-	-	48	64	80	96

Installation in concrete

Type of fencing	Ref	Kit with	Total length of fencing					
			2.0m	4.0m	6.0m	8.0m	10.0m	12.0m
	P 9283 (2.35m)	start/end post	1	1	1	1	1	1
	P 9275 (2.35m)	connection post	0	1	2	3	4	5
	P 9555	planks (linear meter)	26	52	78	104	130	156
	P 9283 (2.35m)	start/end post	-	2	2	2	2	2
	P 9275 (2.35m)	connection post	-	0	1	2	3	4
	P 9555	planks (linear meter)	-	52	78	104	130	156
	P 9283 (2.35m)	start/end post	-	-	3	3	3	3
	P 9275 (2.35m)	connection post	-	-	0	1	2	3
	P 9555	planks (linear meter)	-	-	78	104	130	156

Installation on wall

Start/end post

Connection post

Corner post 90° - 179°

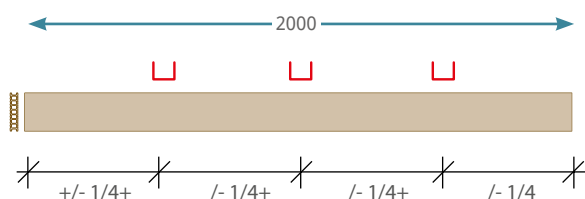
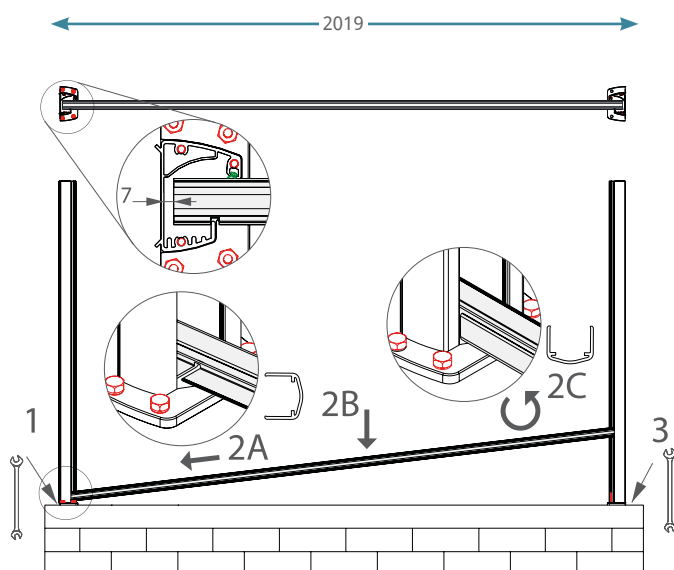
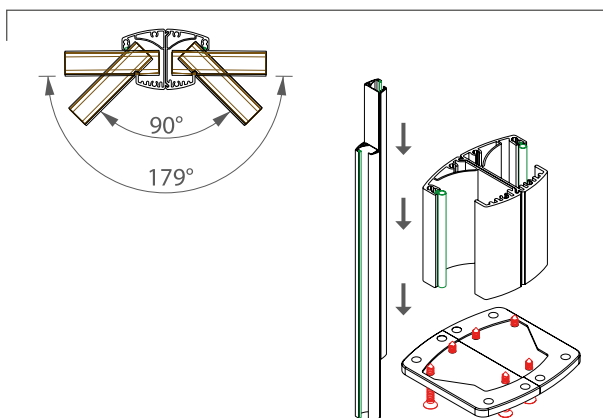
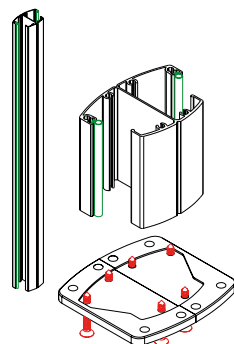
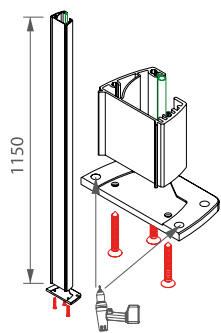

! Important

Fixation depending on foundation.
Please follow the manufacturer's
instructions for all products.

IMPORTANT:
Keep on both sides a
minimum dilatation space
of 7mm between the
aluminium finishing profile,
the plank and the post.

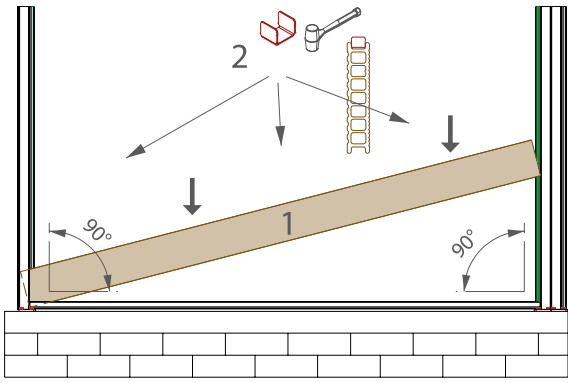

! Important

Please pay attention to the installation direction of the planks.

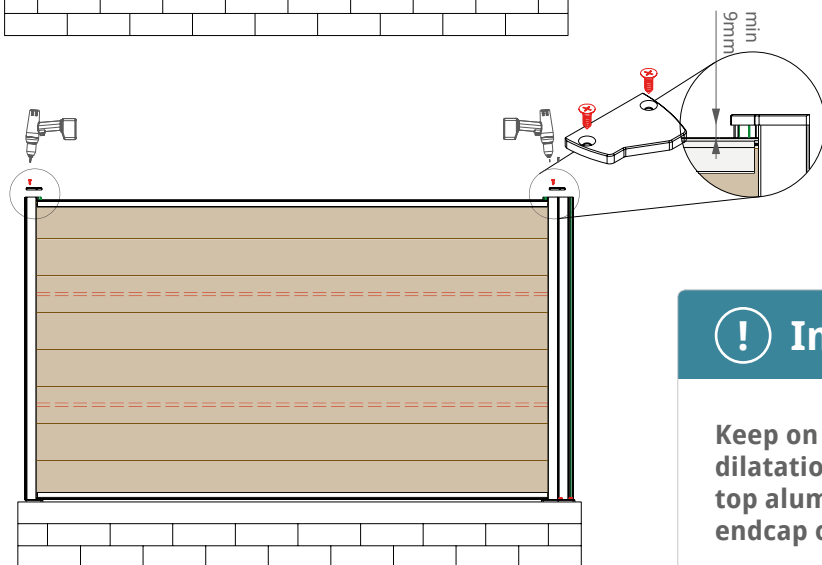
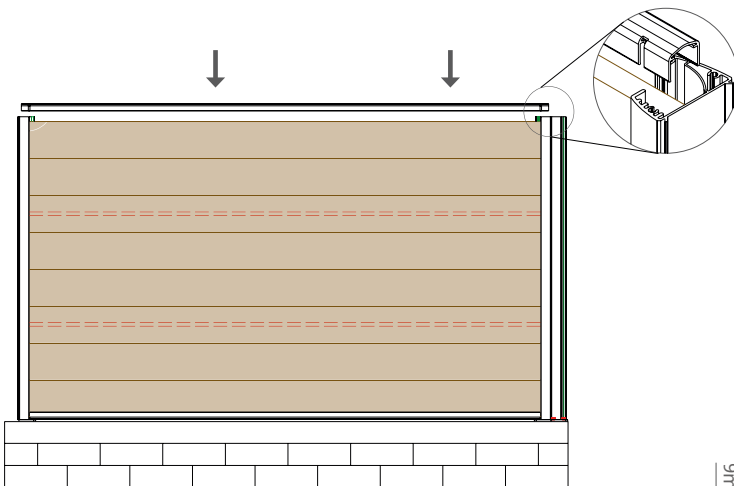
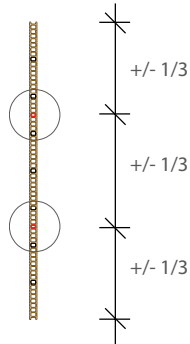
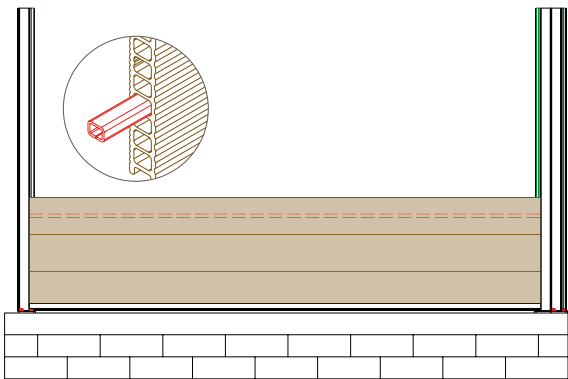
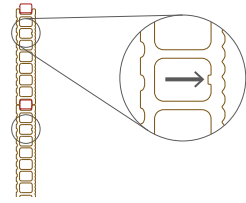

! Important

Keep on both sides a minimum dilatation space of 9mm between the top aluminium finishing profile and the endcap of the post.

Installation in concrete

Start/end post

Connection post

Corner post 90° - 179°

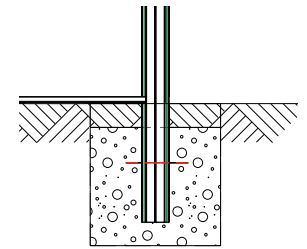
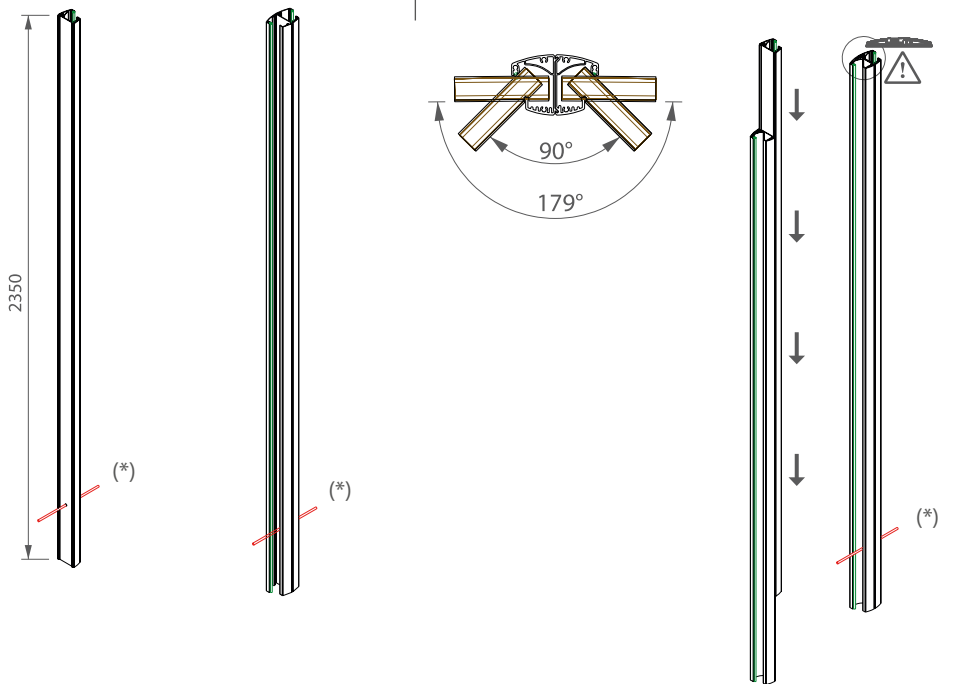

(*) NOT INCLUDED in the kit
(\varnothing 8 mm, min. 200 mm)

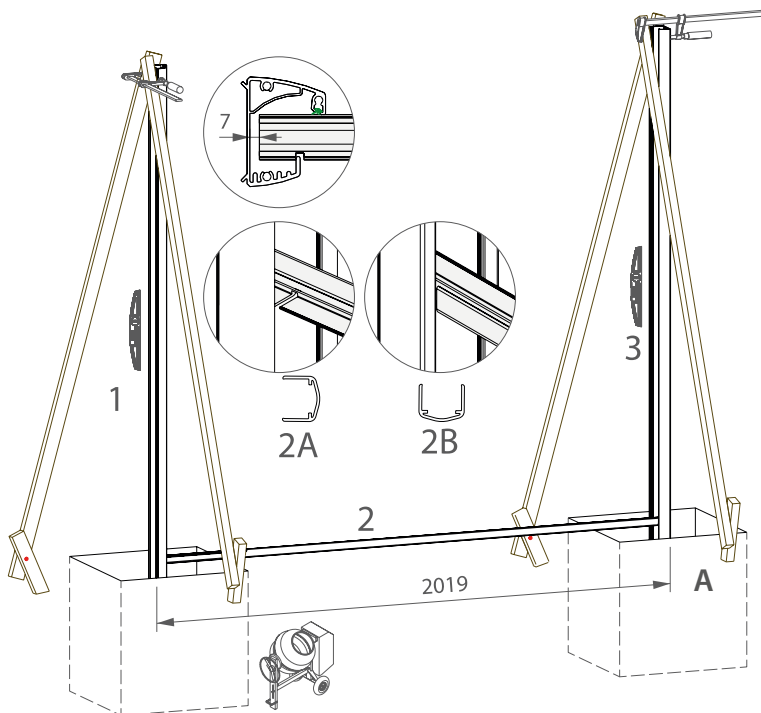

! Important

A = concrete (fine grind, sand, min. 200 kg/m³ cement) Block the lower U-profile (2) to avoid sagging.

IMPORTANT:
Keep a minimum dilatation space of 7mm between the aluminium finishing profile, the plank and the post.

Post 2,35 m
 B = soil (100 mm).
 C = concrete (min. 500 mm).

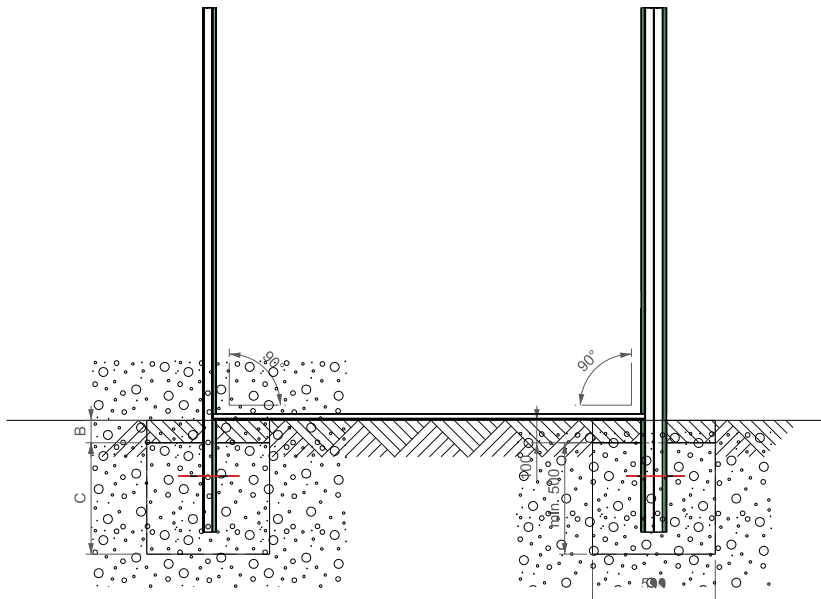

! Important

Please pay attention to the installation direction of the planks.

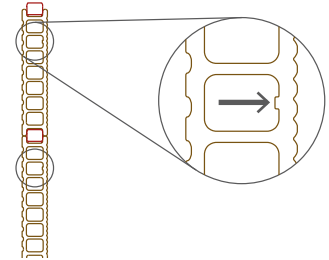

IMPORTANT:
 keep on both sides a minimum dilatation space of 9mm between the top aluminium finishing profile and the endcap of the post.

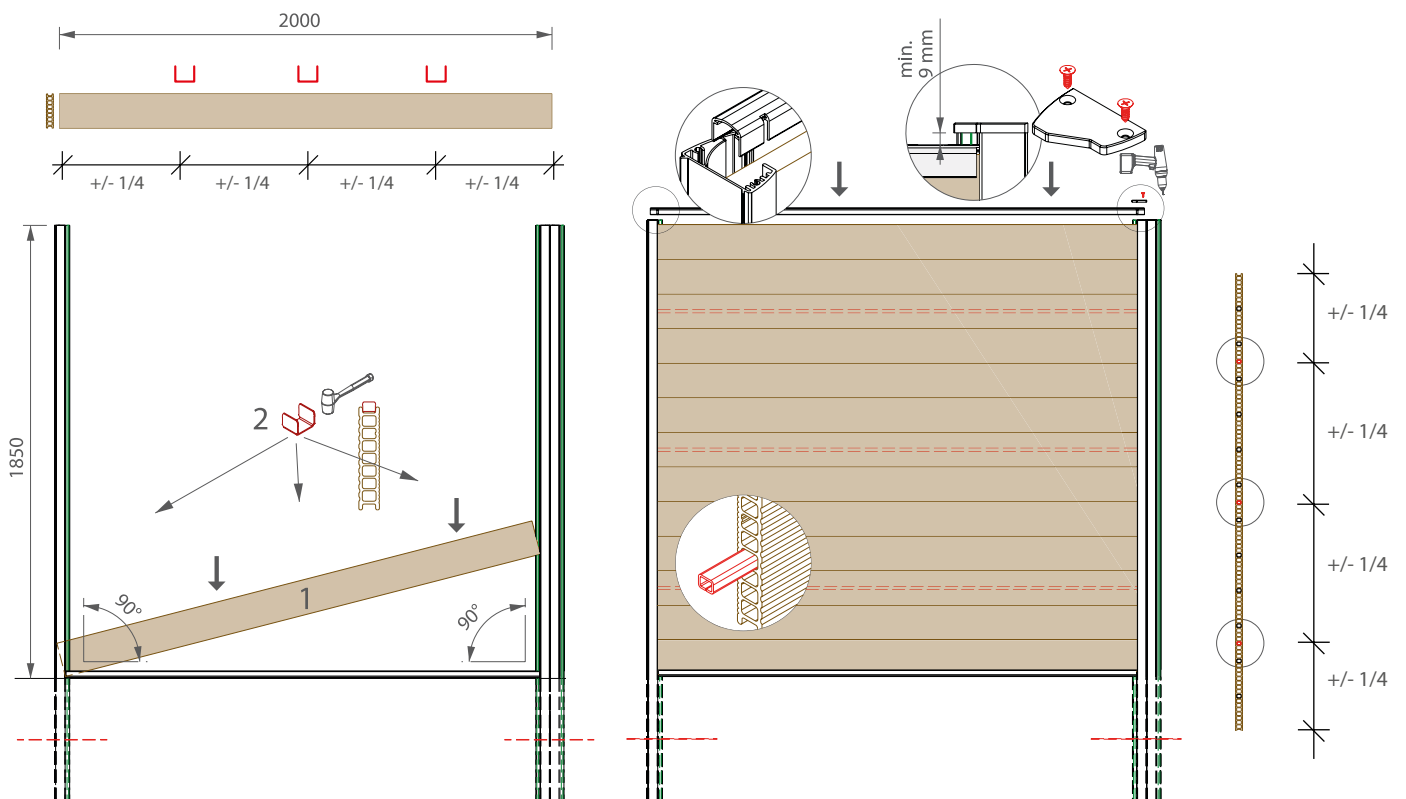

Blank page with horizontal dotted lines for writing.

This document contains proprietary and confidential information, do not copy or disclose this information without the express written consent of Deeplas. Deeplas reserves the right to change this drawing and any associated documents.